

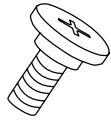

A X 2
(M6 x L14)



C X 2
(M6 x L12)



B X 5
(M5 x L15)

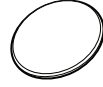

X 1

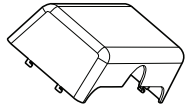

X 1

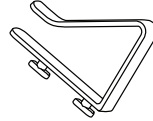

X 6

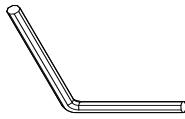

X 1



X 2



X 1

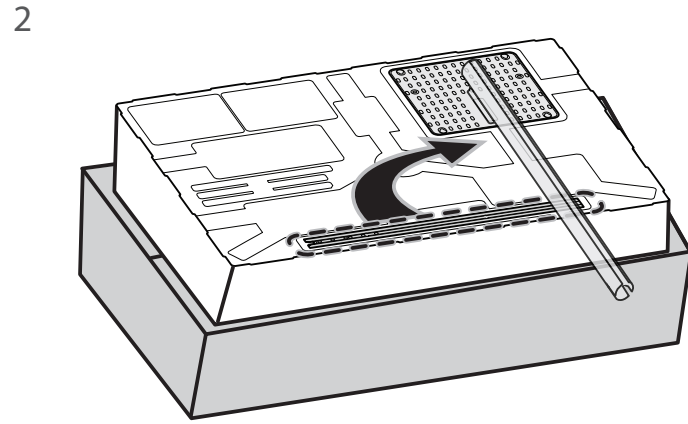
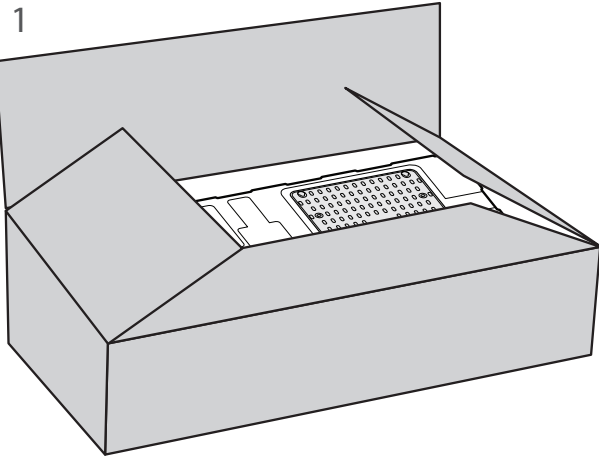
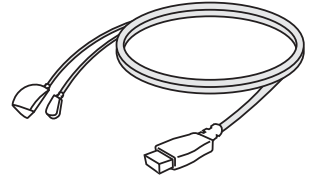
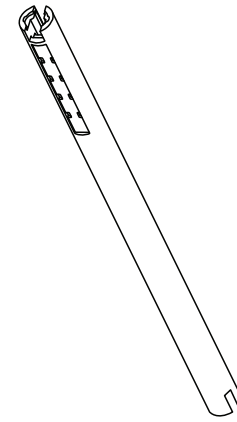
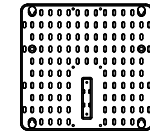
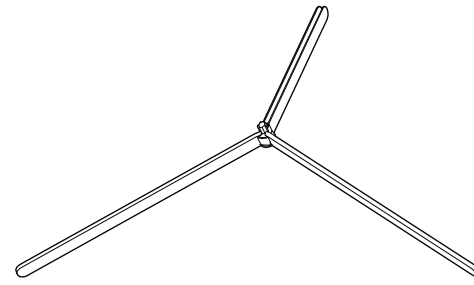

[VESA : 300 X 300]

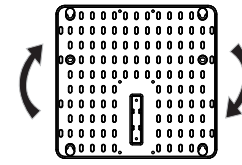
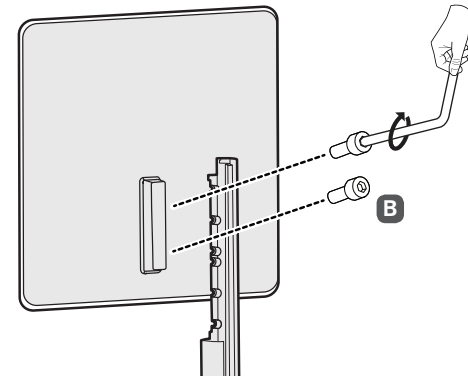

[VESA : 300 X 200]

